

ILMS5360

MICROCIRCUIT FOR REMOTE CONTROL SYSTEMS

Description

Microcircuit is mini photomodule designed for IR signal reception in remote control systems. Photomodule output signal can be decode directly by microprocessor. Advantage is resistant functioning and protection from uncontrolled output impulse.

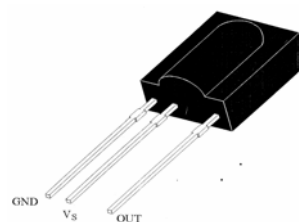

Characteristic:

- Photodiode and preamplifier in one frame
- Inside band-pass filter for subcarrier frequency (PCM) of 36 Hz
- Frame material protects from daylight exposure
- Special screen protects from external electric fields exposure
- Supply voltage 5V
- TTL and CMOS compability

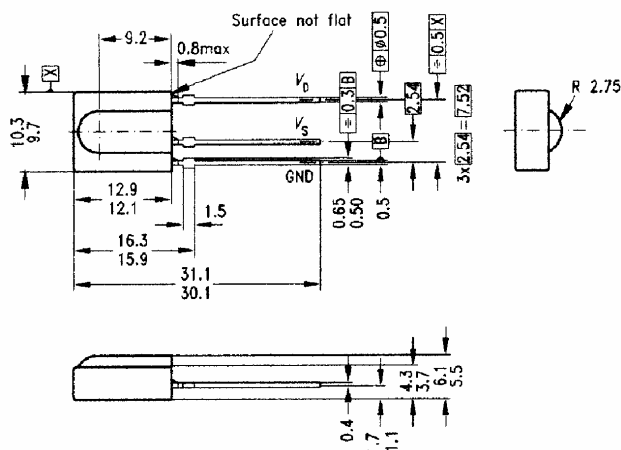

Block diagram

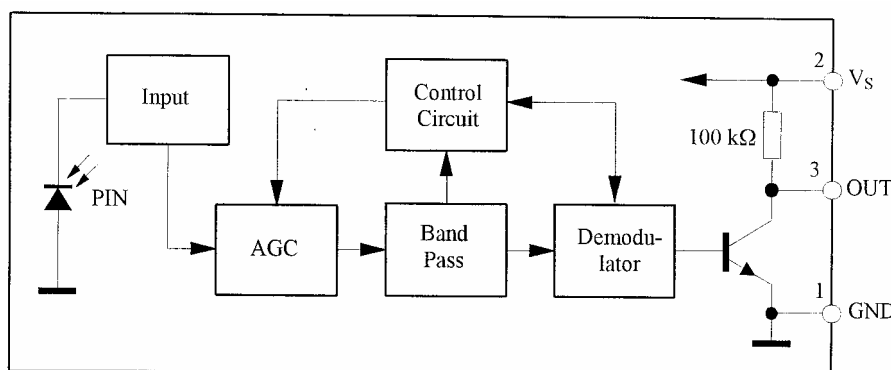

Korzhenevskogo 12, Minsk, 220108, Republic of Belarus
 Fax: +375 (17) 278 28 22,
 Phone: +375 (17) 278 07 11, 212 24 70, 212 24 61,
 212 69 16
 E-mail: office@bms.by
 URL: www.bms.by

BELMICROSYSTEMS

ILMS5360

Limiting parameters values Tamb=25°C

Title	Measurements condition	Notation	Meaning	Measurement unit
Supply voltage		Vs	4.5 ÷ 5.5	V
Power current		Is	0.8	mA
Transition temperature		T _J	100	°C
Storage temperature		Tstg	-25.÷.+85	°C
Operating temperature		Tamb	-25 ÷ +85	°C
Power consumption	(Tamb = 85 °C)	Ptot	50	mW

Basic characteristics Tamb=25°C

Title	Measurements conditions	Notation	MIN	TYP	MAX	Measurement unit.
Current consumption (Output 2)	Vs = 5 V, Ev = 0	I _{SD}	0.4	0.5	0.8	mA
Current consumption (Output 2)	Vs = 5 V, Ev = 40 klx, sun light	I _{SH}	-	1.0	-	mA
Transmission distance	Ev = 0, test signal, IR-diode TSIP5201, I _p = 1.5 A	d	-	32	-	m
Output voltage of low level (Output 3)	I _{OSL} = 0.5 mA, Ee = 0.5 mW/M ² , f=f ₀ , t _{PI} /N=0,4 Test signal	V _{OSL}	-	-	250	mV
Minimum density of IR-radiating power*	t _{PO} =t _{PI} Test signal	E _{emin}	±160	0.6	0.4	mW/m ²
Maximum radiation	Test signal	E _{emax}	-	-	20	W/m ²

* - accordance with customer order programming of subcarrier frequency can be fulfilled (PCM) F₀ in range of(36-40) kHz

Circuit connection.

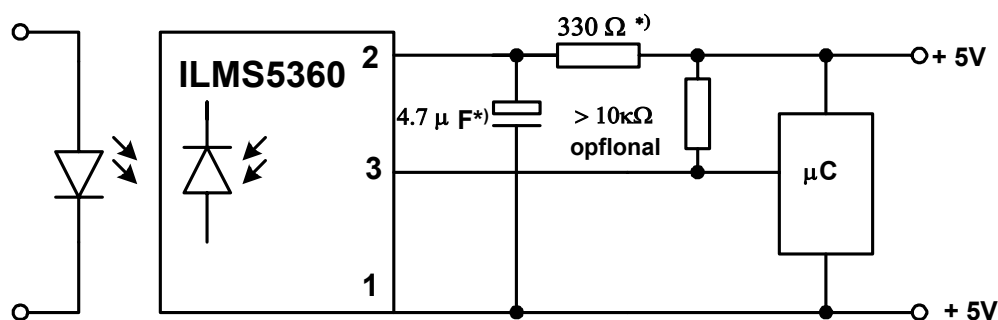

*) - it is necessary only for power source interference suppression + 5V.



Korzhenevskogo 12, Minsk, 220108, Republic of Belarus
 Fax: +375 (17) 278 28 22,
 Phone: +375 (17) 278 07 11, 212 24 70, 212 24 61, 212 69 16
 E-mail: office@bms.by
 URL: www.bms.by

BELMICROSYSTEMS

ILMS5360
Input test signal

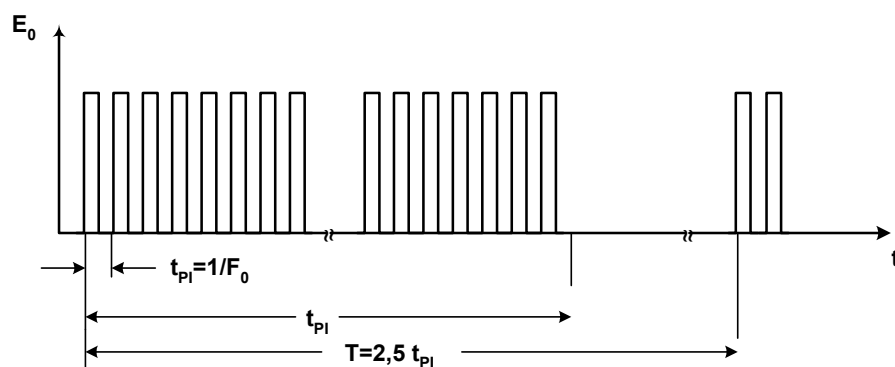

Input signal

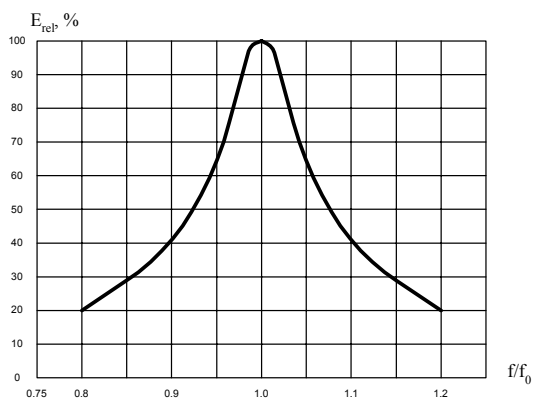
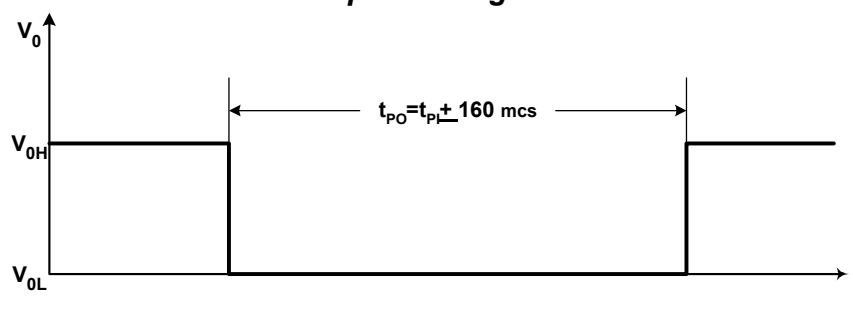

Figure 1 – Dependence of sensitivity as function of normalized frequency, $T_{amb} = 25^\circ\text{C}$ (amplitude-frequency response).

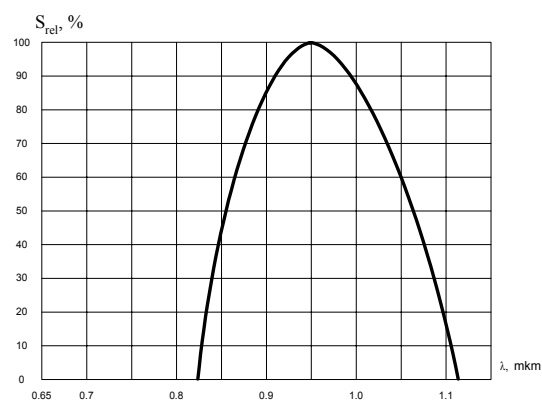

Figure 2 – Dependence of sensitivity on IR-radiation wave length by $T_{amb} = 25^\circ\text{C}$ (spectral response).



Korzhenevskogo 12, Minsk, 220108, Republic of Belarus
 Fax: +375 (17) 278 28 22,
 Phone: +375 (17) 278 07 11, 212 24 70, 212 24 61, 212 69 16
 E-mail: office@bms.by
 URL: www.bms.by

BELMICROSYSTEMS

ILMS5360

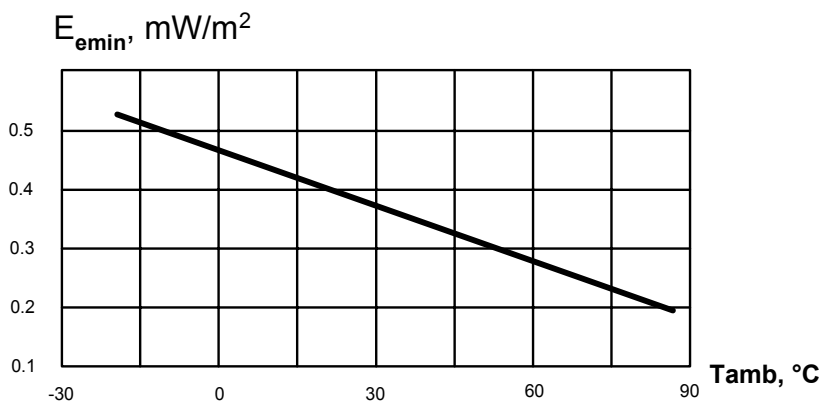

Figure 3 – Dependence of IR radiation minimum power density parameter on environment temperature (microcircuit sensibility) by $U_s = 5B$.

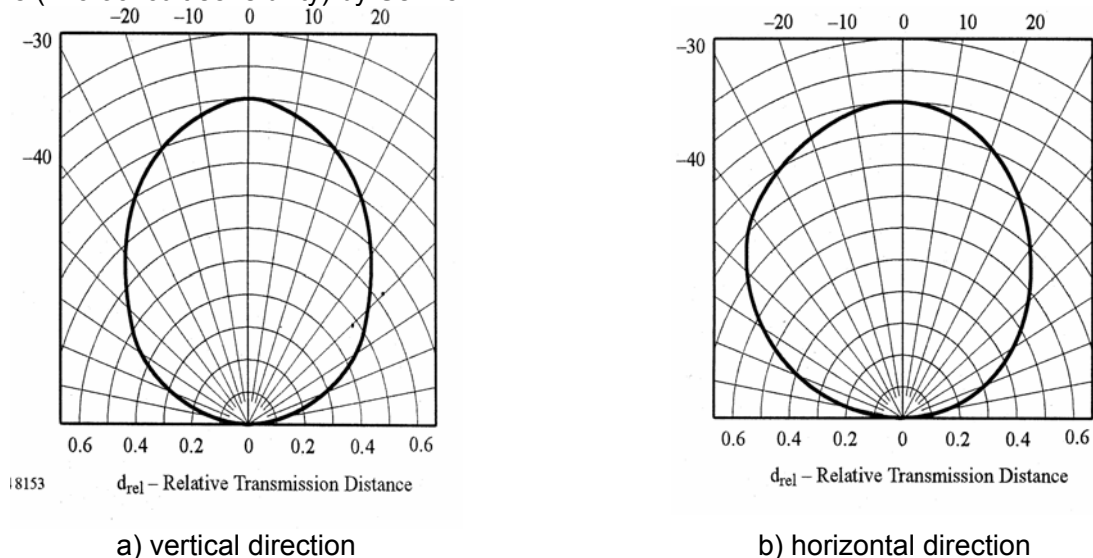

Figure 4 – Dependence of relative sensitivity on infra-red source angle turn.



Korzhenevskogo 12, Minsk, 220108, Republic of Belarus
 Fax: +375 (17) 278 28 22,
 Phone: +375 (17) 278 07 11, 212 24 70, 212 24 61,
 212 69 16
 E-mail: office@bms.by
 URL: www.bms.by

BELMICROSYSTEMS